

# Technical Information — Sizes

## VersaEdge

The Standard VersaEdge Stair Nose combines style and function to enhance the beauty of a staircase or step. For use on flooring with an overall thickness of up to 19 mm (0.75").

**Surface Material:** High Wear Resistant Aluminum Oxide Laminate

**Core Material:** PVC

## VT-VE Shim

To be used with VersaEdge for floors for flush installations (See illustrations at bottom right).

**Material:** Standard MDF/HDF

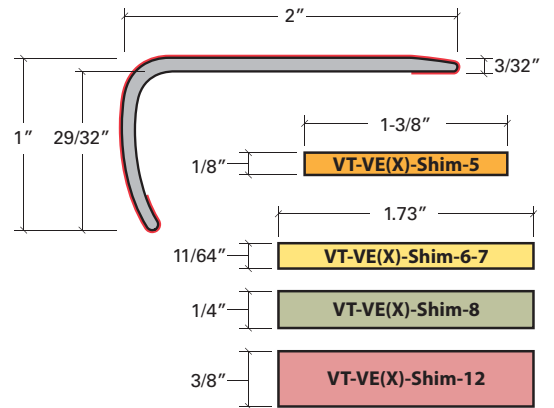

# Installation

## Overlap Install

### Locked Down Install

Used where floating of the floor is not required, as with Stair Tread or Glued-Down/Nailed-Down floors. This can be used on floating floors where expansion and contraction will occur on the opposite side of the flooring plane.

### Laminate/Engineered Wood Vinyl/LVT

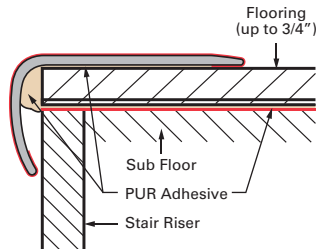

### Floating Install

#### Vinyl/LVT

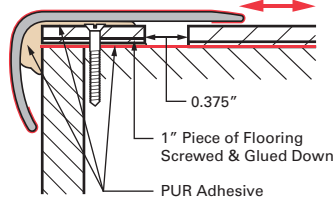

#### Laminate/Engineered Wood

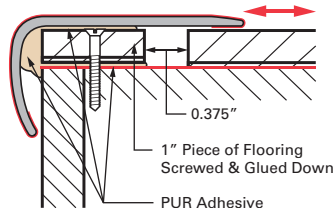

## Flush Install

### Locked Down Install

Used where floating of the floor is not required, as with Stair Tread or Glued-Down/Nailed-Down floors. This can be used on floating floors where expansion and contraction will occur on the opposite side of the flooring plane.

**Tongue side of plank MUST face the VersaEdge. VersaEdge, Shims, and flooring planks must be glued down to subfloor.**

### Flooring with an overall thickness of 2-3 mm

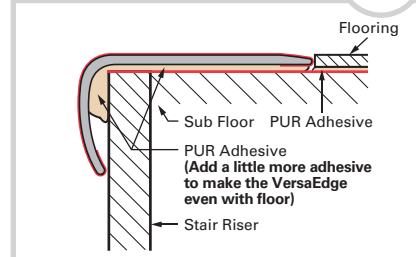

### Flooring with an overall thickness of 4 mm

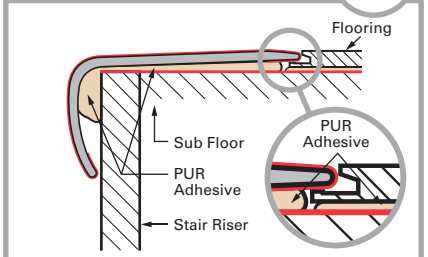

### Flooring with an overall thickness of 5-5.5 mm

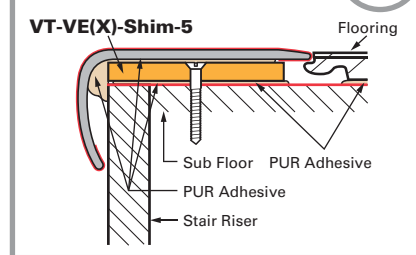

### Flooring with an overall thickness of 6-7 mm

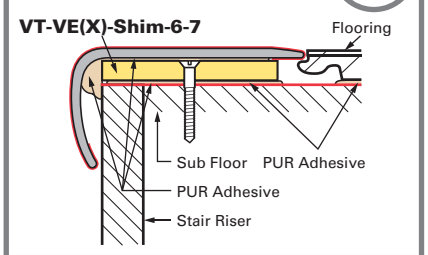

### Flooring with an overall thickness of 8 mm

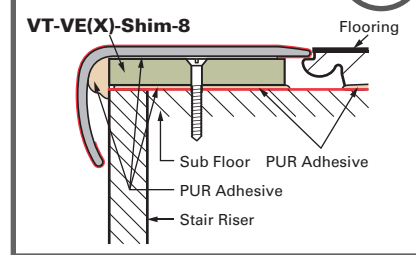

### Flooring with an overall thickness of 12 mm

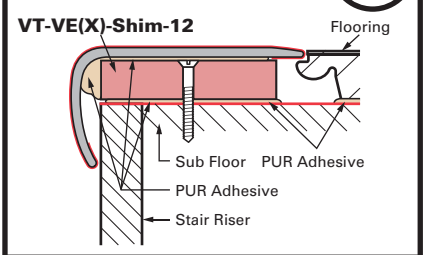

VersaEdge Stair Nose

## “Lock-Down” Installation

Flooring with an overall thickness of up to 19 mm (0.75")

### Step 1

Install the riser flush to the stair. Glue down flooring planks (for more details see manufacturers recommendations). Then, clean flooring and molding as directed below:

#### CLEANING PREPARATION FOR BOTH SURFACES

Preparing the floor & molding as outlined is mandatory to achieve the required bonding strength

1. Use a damp cloth (water only) to clean both surfaces of loose particles or surface films.
2. Roughen the surfaces with sandpaper (100-150 grit), sanding sponge or metal brush. For flooring, only roughen up area that will be covered (1.25" to 1.5").
3. Degrease both surfaces to remove all traces of oil, grease, dust, and fingerprints by using a light solvent such as isopropyl alcohol (Refer to the manufacturer's recommendations for additional safe cleaning agents).
4. Let both surfaces dry thoroughly before applying adhesive.

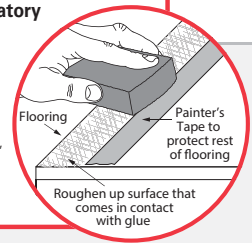

### Step 2

Turn VersaEdge over and roughen the inside surface of the VersaEdge to increase bond by means of 60 grit sandpaper, sanding sponge, or a metal brush.

### Step 3

Next, apply a generous bead of a **Premium Polyurethane Construction Adhesive** along the entire inside corner.

Underside of molding generously covered with PUR adhesive

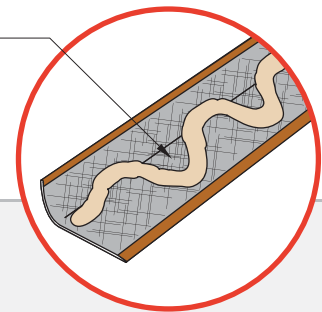

### Step 4

Touch the bottom of molding to the stair riser and carefully roll the stair nose in place. Make any final adjustments before you push the molding all the way down. Once it's in the final position, press down firmly with your hands and make your way down the entire stair nose. It may take 2 or 3 passes to set it firmly in place.

### Step 5

Let the adhesive cure for at least 4 hours before any walking on it. For exposure to full traffic, wait 24 to 48 hours.

**NOTE:** Complete cure takes 48 hours.

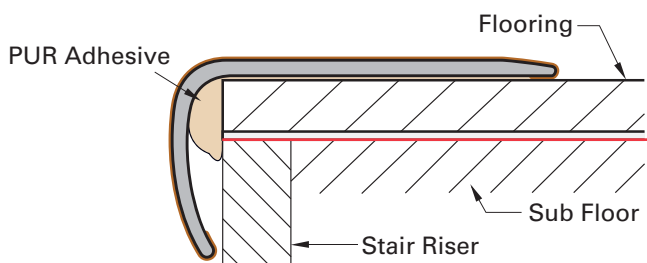
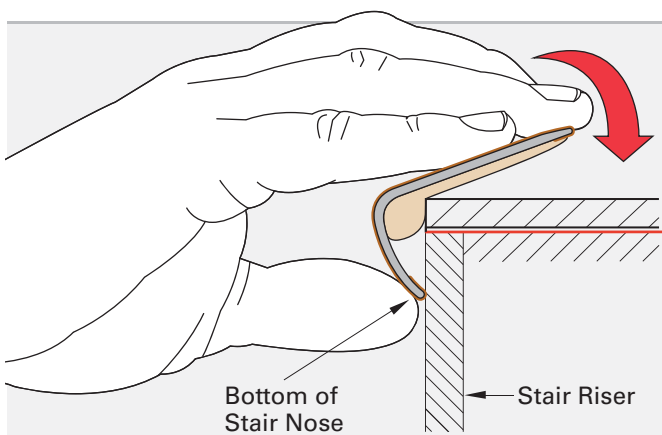
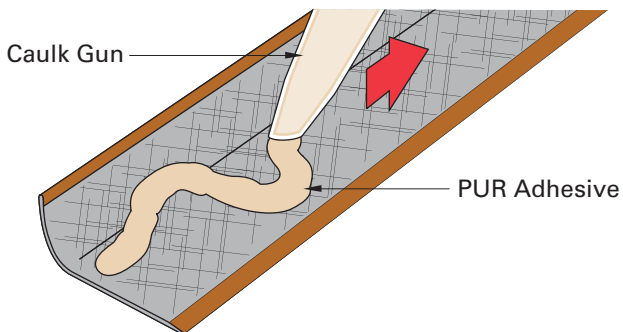
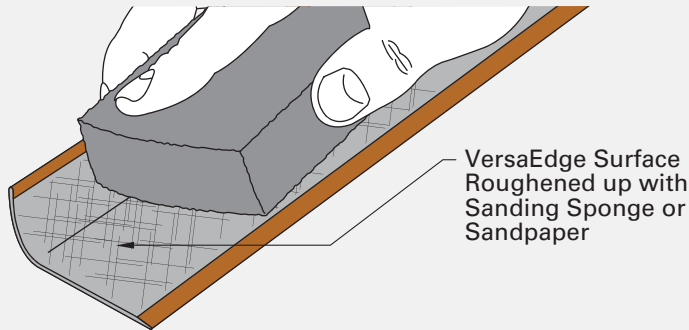
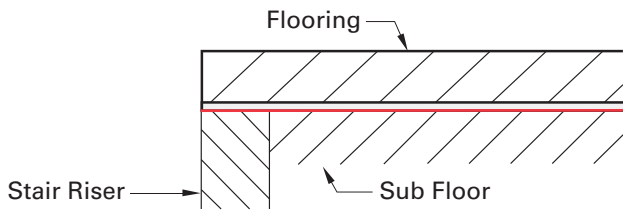

VersaEdge Stair Nose

## "Floating" Installation

Flooring with an overall thickness of up to 19 mm (0.75")

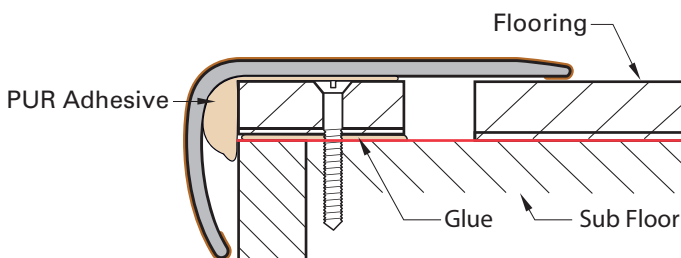
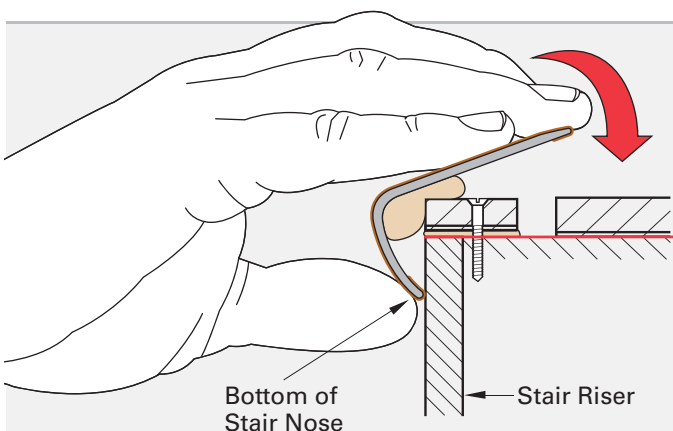
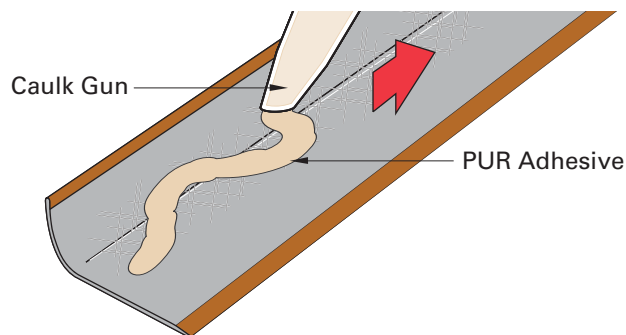
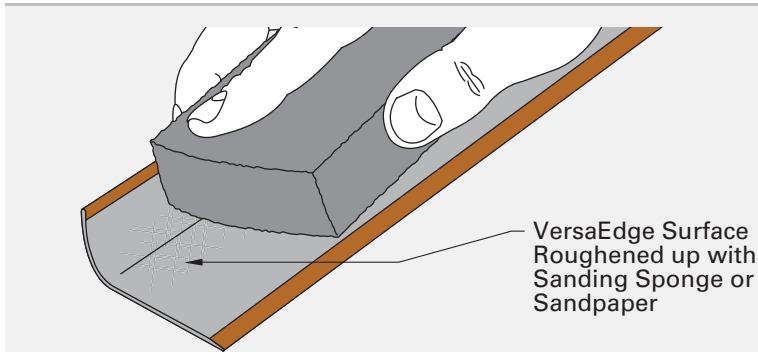
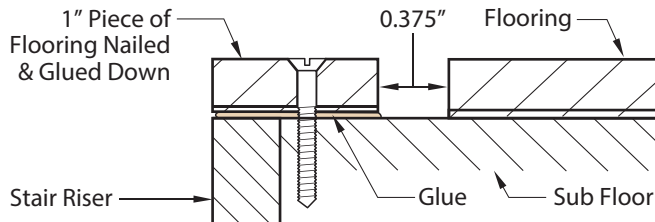

### Step 1

Install the riser flush to the stair. Cut a 1" wide strip of your floor. Drill, counter-sink, screw and glue it flush to the stair riser. Install flooring 0.375" from the glued down 1" strip. **DO NOT glue flooring down.** Clean flooring and molding as directed below:

#### CLEANING PREPARATION FOR BOTH SURFACES

Preparing the floor & molding as outlined is mandatory to achieve the required bonding strength

1. Use a damp cloth (water only) to clean both surfaces of loose particles or surface films.
2. Roughen the surfaces with sandpaper (100-150 grit), sanding sponge or metal brush. For flooring, only roughen up area that will be covered (1.25" to 1.5").
3. Degrease both surfaces to remove all traces of oil, grease, dust, and fingerprints by using a light solvent such as isopropyl alcohol (Refer to the manufacturer's recommendations for additional safe cleaning agents).
4. Let both surfaces dry thoroughly before applying adhesive.

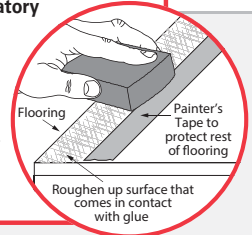

### Step 2

Turn VersaEdge over and roughen the inside surface of the VersaEdge to increase bond by means of 60 grit sandpaper, sanding sponge, or a metal brush.

### Step 3

Next, apply a generous bead of a **Premium Polyurethane Construction Adhesive** along the entire inside corner. **Be sure to NOT put adhesive towards the front of the molding.**

Underside of molding generously covered with PUR adhesive

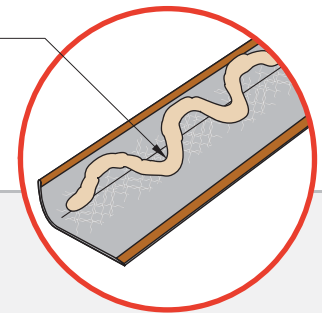

### Step 4

Touch the bottom of molding to the stair riser and carefully roll the stair nose in place. Make any final adjustments before you push the molding all the way down. Once it's in the final position, press down firmly with your hands and make your way down the entire stair nose. It may take 2 or 3 passes to set it firmly in place.

### Step 5

Let the adhesive cure for at least 4 hours before any walking on it. For exposure to full traffic, wait 24 to 48 hours.

**NOTE: Complete cure takes 48 hours.**

## “Flush Lock-Down” Installation

### Step 1

Install the riser flush to the stair. Use VersaEdge to determine where to start your flooring. VersaEdge must fit snugly next to plank. Remove VersaEdge and **glue the flooring plank down**. Clean flooring and molding as directed below:

#### CLEANING PREPARATION FOR BOTH SURFACES

Preparing the floor & molding as outlined is mandatory to achieve the required bonding strength

1. Use a damp cloth (water only) to clean both surfaces of loose particles or surface films.
2. Roughen the surfaces with sandpaper (100-150 grit), sanding sponge or metal brush. For flooring, only roughen up area that will be covered (1.25" to 1.5").
3. Degrease both surfaces to remove all traces of oil, grease, dust, and fingerprints by using a light solvent such as isopropyl alcohol (Refer to the manufacturer's recommendations for additional safe cleaning agents).
4. Let both surfaces dry thoroughly before applying adhesive.

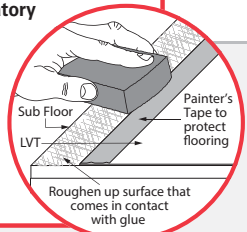

### Step 2

Turn VersaEdge over and roughen the inside surface of the VersaEdge to increase bond by means of 60 grit sandpaper, sanding sponge, or a metal brush.

### Step 3

Next, apply a generous bead of a **Premium Polyurethane Construction Adhesive** along the entire inside corner.

Underside of molding generously covered with PUR adhesive

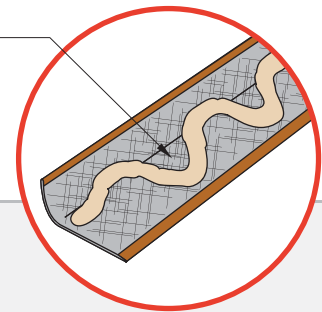

### Step 4

Touch the bottom of molding to the stair riser and carefully roll the stair nose in place. Make any final adjustments before you push the molding all the way down. Once it's in the final position, press down firmly with your hands and make your way down the entire stair nose. It may take 2 or 3 passes to set it firmly in place.

### Step 5

**Allow at least 24 hours for the construction adhesive to form a bond.** You should always start at top of stairs and work your way down to avoid contact with the installed moldings until cured.

**NOTE: Complete cure takes 48-72 hours.**

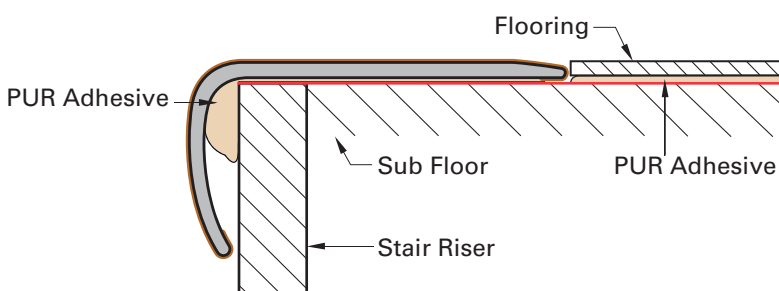
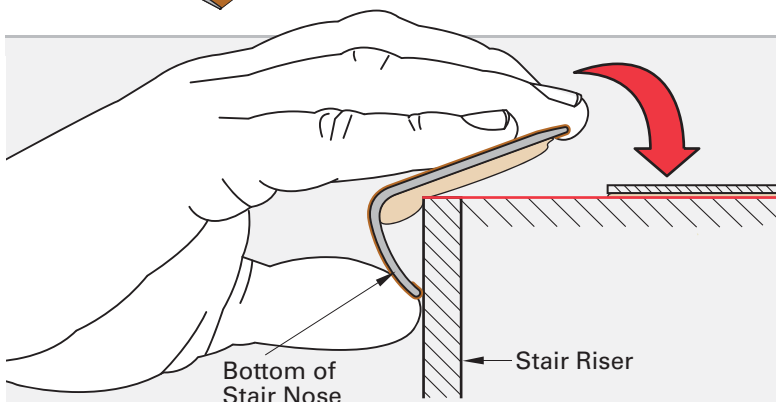
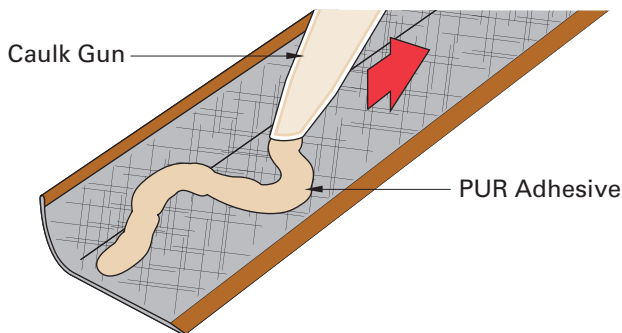
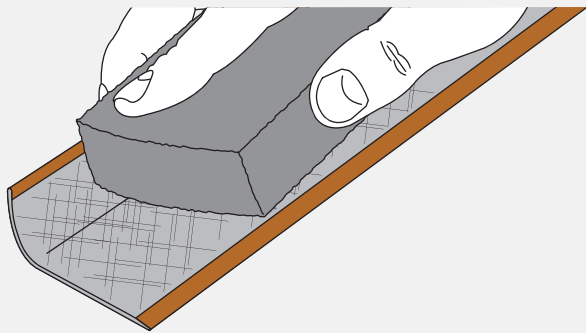
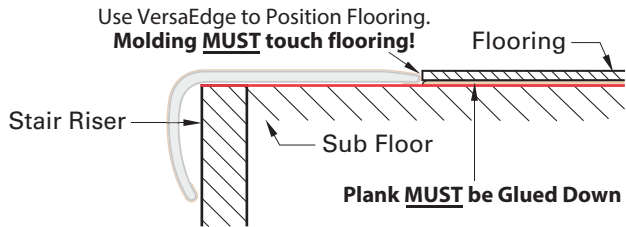

VersaEdge Stair Nose

Installation on **3 mm LVT flooring**

# "Flush Lock-Down" Installation

Flooring with an overall thickness of

**3 mm**

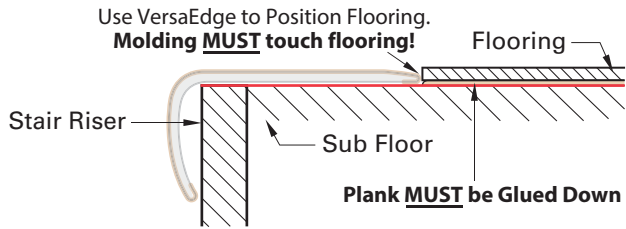

## Step 1

Install the riser flush to the stair. Use VersaEdge to determine where to start your flooring. VersaEdge must fit snugly next to plank. Remove VersaEdge and **glue the flooring plank down**. Clean flooring and molding as directed below:

### CLEANING PREPARATION FOR BOTH SURFACES

Preparing the floor & molding as outlined is mandatory to achieve the required bonding strength

1. Use a damp cloth (water only) to clean both surfaces of loose particles or surface films.
2. Roughen the surfaces with sandpaper (100-150 grit), sanding sponge or metal brush. For flooring, only roughen up area that will be covered (1.25" to 1.5").
3. Degrease both surfaces to remove all traces of oil, grease, dust, and fingerprints by using a light solvent such isopropyl alcohol (Refer to the manufacturer's recommendations for additional safe cleaning agents).
4. Let both surfaces dry thoroughly before applying adhesive.

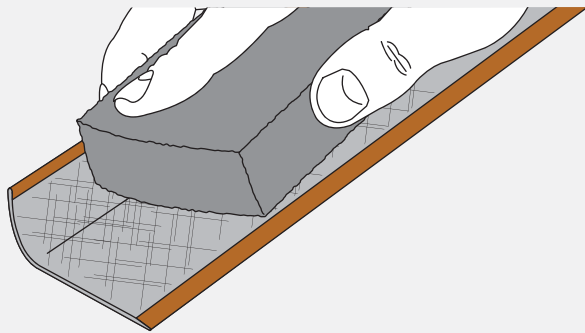
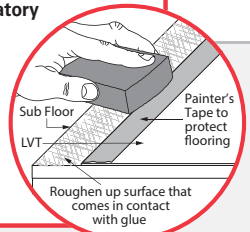

## Step 2

Turn VersaEdge over and roughen the inside surface of the VersaEdge to increase bond by means of 60 grit sandpaper, sanding sponge, or a metal brush.

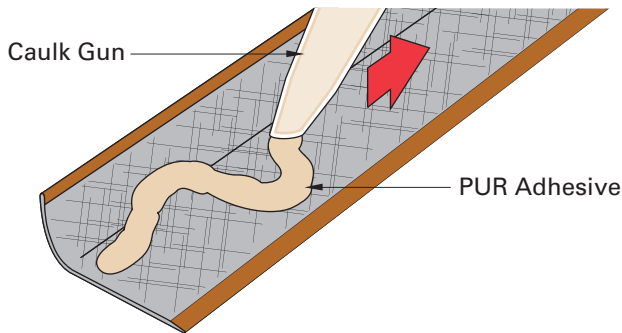

## Step 3

Next, apply a generous bead of a **Premium Polyurethane Construction Adhesive** along the entire inside corner. Reveal edge of plank may show when VersaEdge is installed. To compensate, apply a little more adhesive to the molding.

Underside of molding generously covered with PUR adhesive

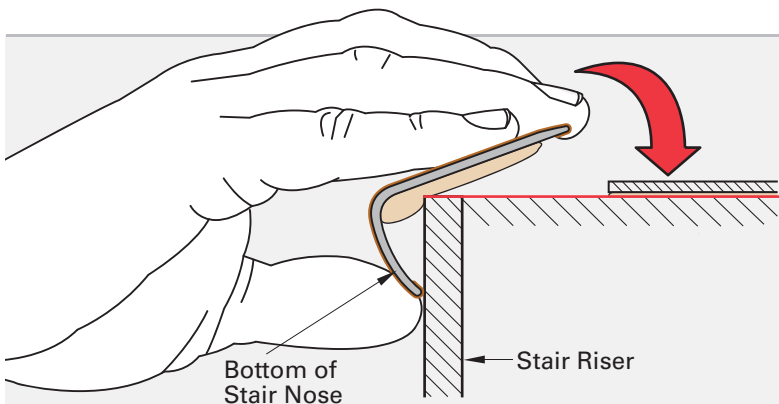
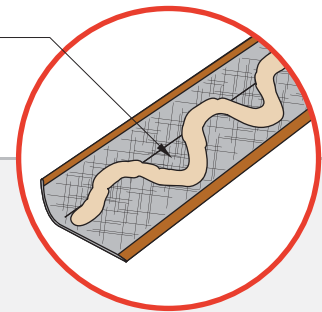

## Step 4

Touch the bottom of molding to the stair riser and carefully roll the stair nose in place. Make any final adjustments before you push the molding all the way down. Once it's in the final position, press down firmly with your hands and make your way down the entire stair nose. It may take 2 or 3 passes to set it firmly in place.

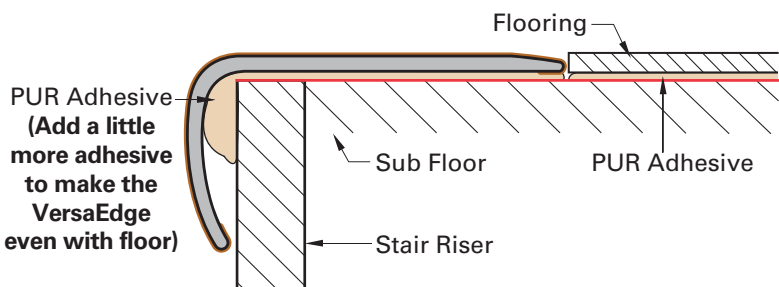

## Step 5

**Allow at least 24 hours for the construction adhesive to form a bond.** You should always start at top of stairs and work your way down to avoid contact with the installed moldings until cured.

**NOTE: Complete cure takes 48-72 hours.**



“Flush Lock-Down” Installation

Flooring with an overall thickness of

4 mm

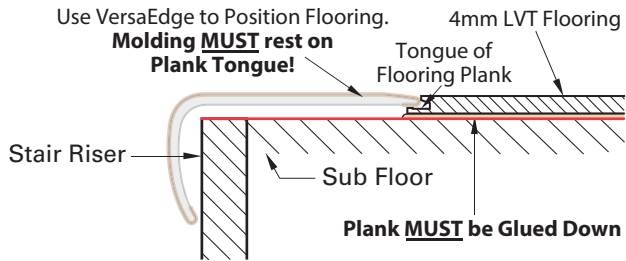

**Step 1**

Install the riser flush to the stair. Use VersaEdge to determine where to start your flooring. **Tongue side of flooring plank MUST face VersaEdge** so VersaEdge can fit snugly onto Tongue. Remove VersaEdge and **glue the flooring plank down**. Clean flooring and molding as directed below:

**CLEANING PREPARATION FOR BOTH SURFACES**

Preparing the floor & molding as outlined is mandatory to achieve the required bonding strength

1. Use a damp cloth (water only) to clean both surfaces of loose particles or surface films.
2. Roughen the surfaces with sandpaper (100-150 grit), sanding sponge or metal brush. For flooring, only roughen up area that will be covered (1.25" to 1.5").
3. Degrease both surfaces to remove all traces of oil, grease, dust, and fingerprints by using a light solvent such isopropyl alcohol (Refer to the manufacturer's recommendations for additional safe cleaning agents).
4. Let both surfaces dry thoroughly before applying adhesive.

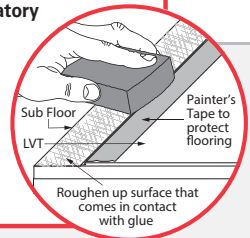

**Step 2**

Turn VersaEdge over and roughen the inside surface of the VersaEdge to increase bond by means of 60 grit sandpaper, sanding sponge, or a metal brush.

**Step 3**

Next, apply a generous bead of a **Premium Polyurethane Construction Adhesive** along the entire inside corner. Reveal edge of plank may show when VersaEdge is installed. To compensate, apply a little more adhesive to the molding.

Underside of molding generously covered with PUR adhesive

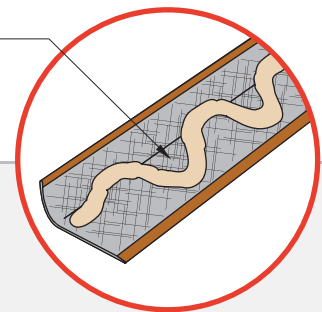

**Step 4**

Touch the bottom of molding to the stair riser and carefully roll the stair nose in place. Make any final adjustments before you push the molding all the way down. Once it's in the final position, press down firmly with your hands and make your way down the entire stair nose. It may take 2 or 3 passes to set it firmly in place.

**Step 5**

**Allow at least 24 hours for the construction adhesive to form a bond.** You should always start at top of stairs and work your way down to avoid contact with the installed moldings until cured.

**NOTE: Complete cure takes 48-72 hours.**

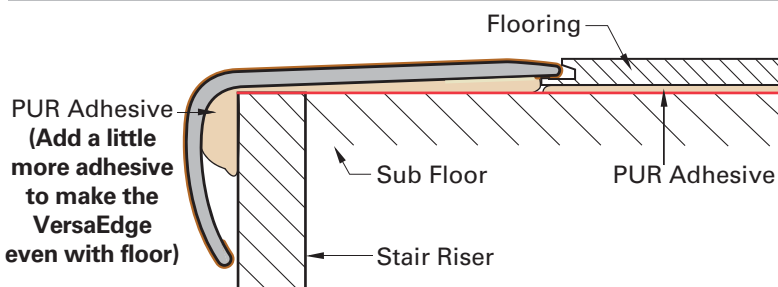
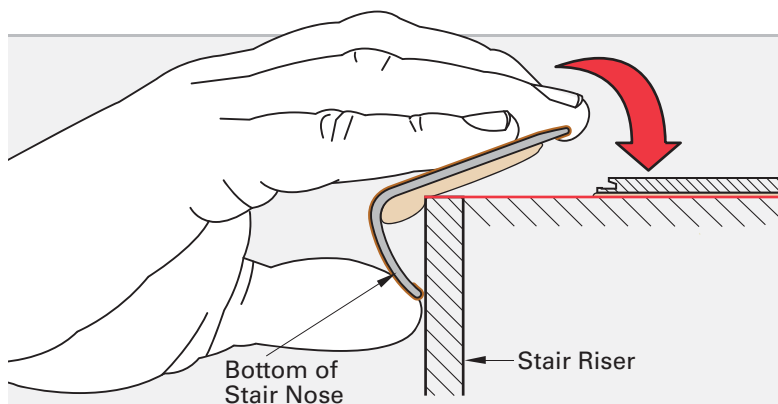
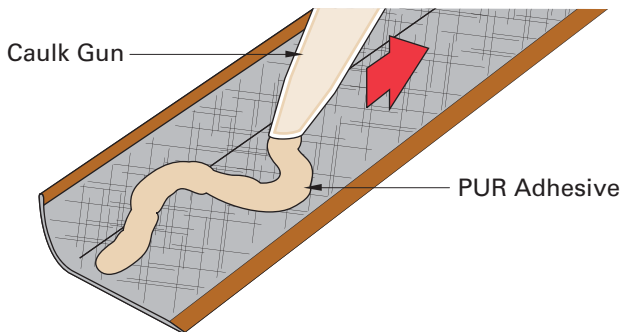
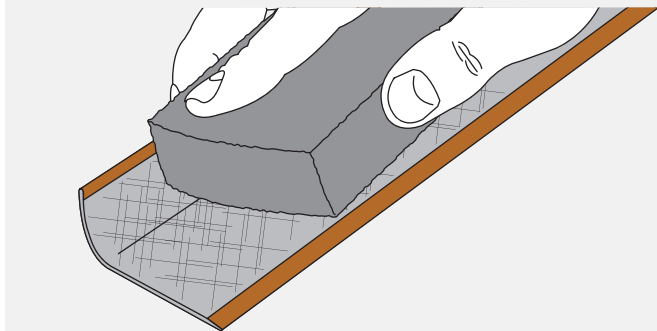

VersaEdge Stair Nose

# Flush "Lock-Down" Installation

Flooring with an overall thickness of

**5-12**  
mm

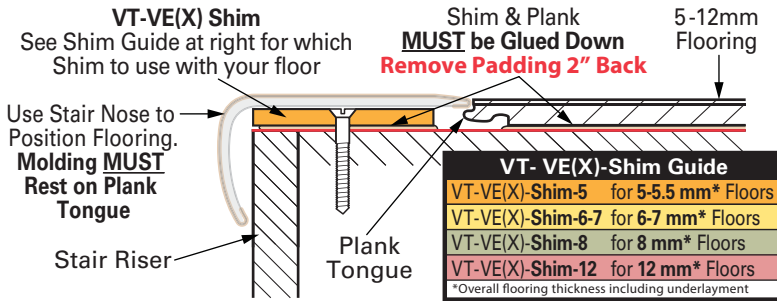

## Step 1

Install the riser flush to the stair. Use VersaEdge & shim to determine where to start your flooring. **Tongue side of flooring plank MUST face VersaEdge** so VersaEdge can fit snugly onto Tongue. Remove VersaEdge and **glue the flooring plank & shim down. Remove padding 2" back** from plank before you glue it down. Clean flooring & molding:

### CLEANING PREPARATION FOR BOTH SURFACES

Preparing the floor & molding as outlined is mandatory to achieve the required bonding strength

1. Use a damp cloth (water only) to clean both surfaces of loose particles or surface films.
2. Roughen the surfaces with sandpaper (100-150 grit), sanding sponge or metal brush. For flooring, only roughen up area that will be covered (1.25" to 1.5").
3. Degrease both surfaces to remove all traces of oil, grease, dust, and fingerprints by using a light solvent such as isopropyl alcohol (Refer to the manufacturer's recommendations for additional safe cleaning agents).
4. Let both surfaces dry thoroughly before applying adhesive.

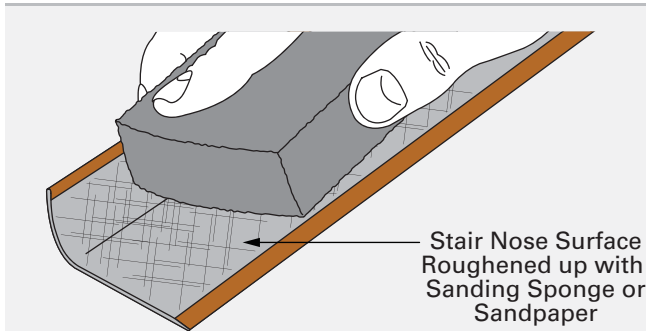
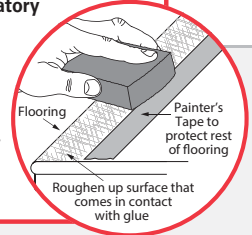

## Step 2

Turn VersaEdge over and roughen the inside surface of the VersaEdge to increase bond by means of 60 grit sandpaper, sanding sponge, or a metal brush.

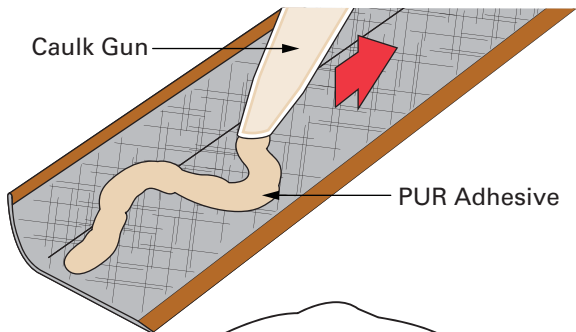

## Step 3

Next, apply a generous bead of a **Premium Polyurethane Construction Adhesive** along the entire inside corner. Reveal edge of plank may show when VersaEdge is installed. To compensate, apply a little more adhesive to the molding.

Underside of molding generously covered with PUR adhesive

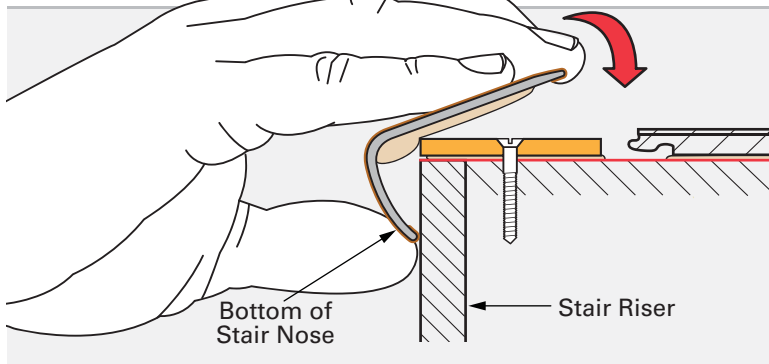
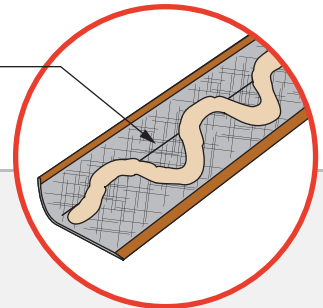

## Step 4

Touch the bottom of molding to the stair riser and carefully roll the stair nose in place. Make any final adjustments before you push the molding all the way down. Once it's in the final position, press down firmly with your hands and make your way down the entire stair nose. It may take 2 or 3 passes to set it firmly in place.

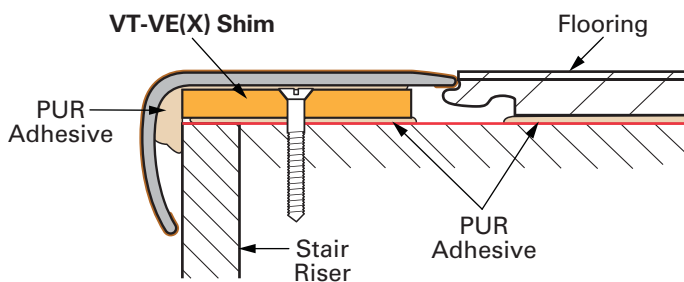

## Step 5

**Allow at least 24 hours for the construction adhesive to form a bond.** You should always start at top of stairs and work your way down to avoid contact with the installed moldings until cured.

**NOTE: Complete cure takes 48-72 hours.**

## MITER CUT INSTALLATION

**IMPORTANT:** Make sure to use safety goggles and thick gloves while using saw and handling the blade

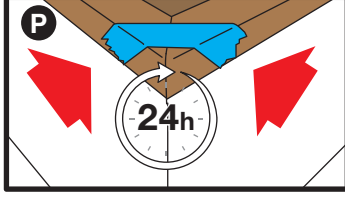
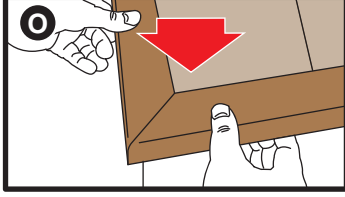
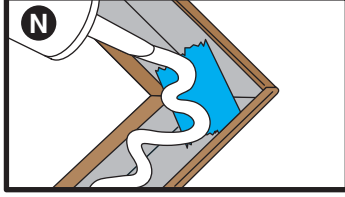
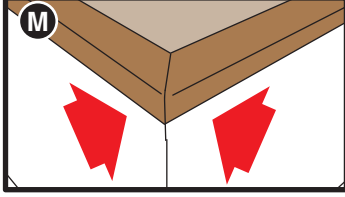
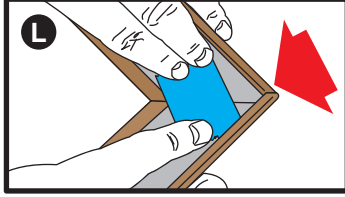
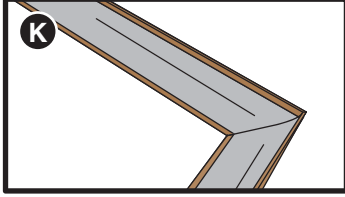
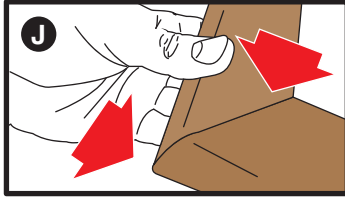
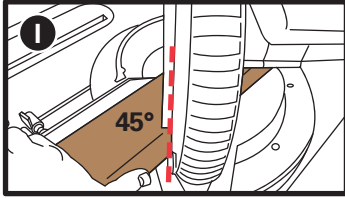
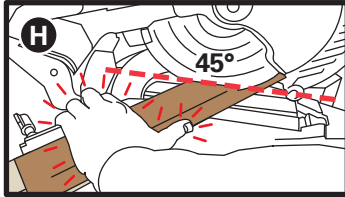
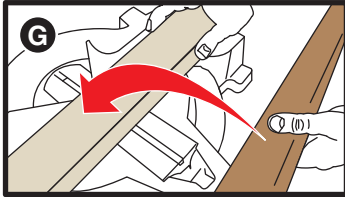
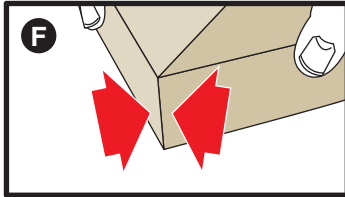
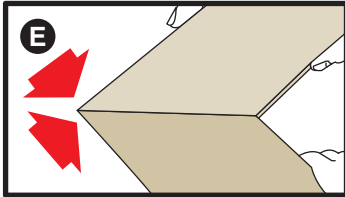
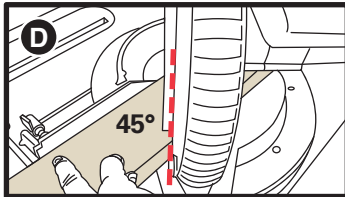
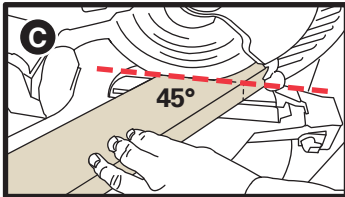
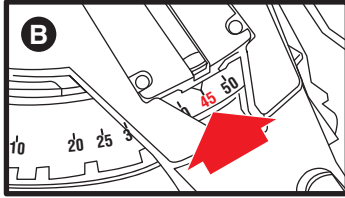
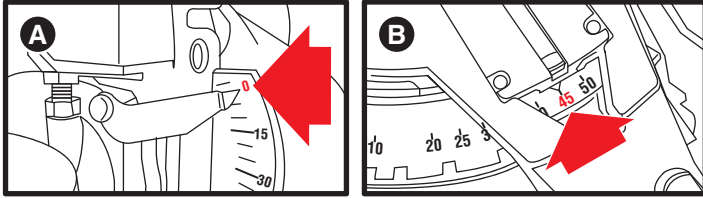

Use the 2x4 miter sample to see if your stair is a true 90 degree corner, often they are not, and you will have to adjust your mitercut by increasing or decreasing your angle accordingly, just make sure you are cutting both pieces with the exact same angle, otherwise your cuts will not line up!!!

### STEP 1 - MAKE TEST CUTS ON SCRAP 2x4

**IMPORTANT:** Make sure the bevel angle is set to ZERO (A).

We highly recommend you do a test cut on 2 scrap pieces of 2x4 to make sure your cuts line up. Set the miter angle to 45 degrees for the first cut (B). Cut the 2x4 (C).

Then change angle of miter cut to 45 degrees in the other direction (D). Cut the other piece of 2x4.

Line up ends of the 2x4s to form a corner (E). Check the pieces to see if they line up correctly with **no gap** on the top or front view (F).

### STEP 2 - CUT YOUR VERSAEDGE (VE)

**IMPORTANT:** Use a scrap 2x4 piece to set VE on while you make the cuts (G). This will keep the VE level while you cut.

Set the miter angle to 45 degrees. Make your cut (H).

**IMPORTANT:** Hold the molding extremely tight, otherwise it will pull in the direction of the blade and your cut will be off

Change miter angle to 45 degrees in the other direction (I). Again, make sure you hold the molding extremely tight. Don't let it move while you make the cut. Cut the other piece of VE.

Check the 2 molding pieces to see if they line up correctly with **no gap** on the top or front view (J).

### STEP 3 - APPLYING VE TO THE STAIRS

After wiping the VE clean from debris, turn the moldings over (K).

Line up the ends of the moldings to form a corner. Place a piece of painter's tape between them to hold them together so you can test the fit (L).

Test the fit on your stairway. Make sure there is no gap between the moldings (M).

After you test the fit, run a thick line of **Titegrip adhesive** (or comparable PUR adhesive) along the inside of each molding (N).

Put the molding in place, pressing down firmly to make sure it is in contact with the floor or stair tread (O). Make sure the edge is square.

While pressing both ends firmly together, stretch a piece of painter's tape tightly across the corner edge to keep the moldings from separating while the adhesive cures (P). Let the adhesive cure for at least 4 hours before any walking on it. **For exposure to full traffic, wait 24-48 hours. NOTE: Complete cure takes 48 hrs.**